

**Thank you for purchasing Rippin' Riders™!
Please note that this software is designed only
for use with the Dreamcast console. Be sure to
read this instruction manual thoroughly before
you start playing Rippin' Riders.**



contents

A BOARDERS PARADISE	2
BEFORE STARTING A GAME	3
STARTING A GAME	4
THE GAME DISPLAY	5
CONTROLS	6
BOARD MANEUVERING TIPS	8
BASIC TRICKS	9
ADVANCED TRICKS	10
EXPERT TRICKS	11
CHARACTER INTRODUCTIONS & SPECIALTY TRICKS	12
GAME MODES	14
THE RESULTS DISPLAY	17
OPTIONS	19

Rippin' Riders is a memory card compatible game [Visual Memory Unit (VMU) sold separately]. In order to save a game file, the VMU you are using must have at least 4 memory blocks of free space available.

A BOARDER'S PARADISE

Battle the elements, your board buddies and your own personal best in *Rippin' Riders*! Compete as one of seven main characters, each with their own unique style, speciality tricks and combos. Uncover hidden courses, boards and features as you keep rippin' it up on your Sega Dreamcast!



BEFORE STARTING A GAME

saving game files

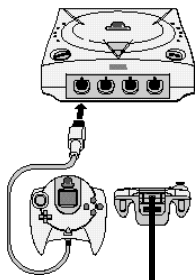

Rippin' Riders is a Visual Memory Unit (VMU) compatible game. Data saved to a game file includes option settings, time scores and other scoring results. To save game data connect a Dreamcast controller to any control port. Then, insert the memory card (VMU) to be used to save the game data into an expansion socket of the controller. With this game, a minimum of 4 blocks of free memory is required to save a game file. Additional free memory is required to save replay data.

CAUTION

Never turn OFF the Dreamcast power, remove the VMU or disconnect the controller while game data is being saved.

using the Jump Pack

When using the Jump Pack with the Dreamcast Controller to play *Rippin' Riders*, always insert the Jump Pack into Expansion Socket 2 of the controller. When the Jump Pack is inserted into Expansion Socket 1 of the Dreamcast Controller, the Jump Pack does not lock into place and may fall out during game play or otherwise inhibit game operation.

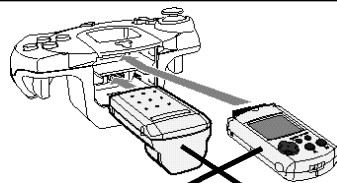

Insert the VMU into Expansion Socket 1 and the Jump Pack into Expansion Socket 2 of the controller.



STARTING A GAME

title screen

Once the title screen appears, press the Start Button to proceed to the mode selection menu.



mode selection screen

Use the Analog Thumb Pad or Direction Pad (D-Pad)   to select a mode and press the  Button to enter your selection. For details on the modes available, see p. 14.



Free Ride

Shred these unique slopes, designed after courses no average boarder would dare try, within the allotted time while racking up trick points as you go.

Super Pipe

Catch some big air and bust loads of tricks while competing in this halfpipe mode.

Match Race

Race against your favorite rival using this split screen fast-paced competition mode.

Options

Use this mode to modify various game settings, perform sound tests, view the rankings, etc. For details, see p. 19.

THE GAME DISPLAY

An explanation of the basic game display is described below. However, note that the actual game display may vary slightly with each mode.

trick points

The current total number of trick points earned.

total time

The current elapsed time.

time

The amount of allotted time remaining.



record & section

This item toggles between the RECORD and SECTION display. RECORD displays the top ranking score for TIME, TRICK and TOTAL. SECTION displays the time clocked (or the current time being clocked) for each of the three sections of the course.



speed

The current speed.

extra time

The amount of extra time earned by performing tricks.

trick total

Whenever you successfully bust a trick, the trick name, trick point value and total number of points earned is displayed here.

BASIC CONTROLS

the Dreamcast Controller

Rippin' Riders is a one to two player game. Before turning the Dreamcast power ON, connect the Dreamcast Controllers and/or other peripheral equipment to the Control Ports of the Dreamcast.

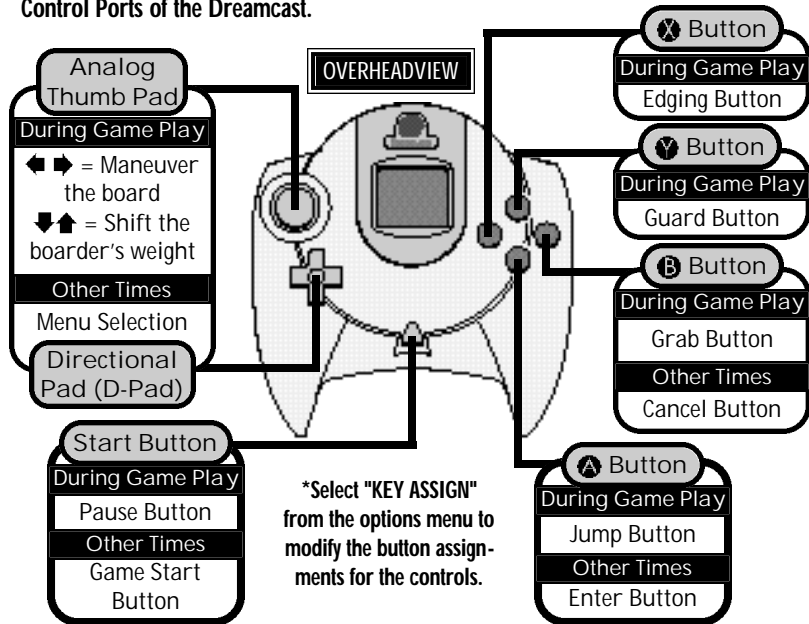

BASIC CONTROLS

To reset the Dreamcast and return to the title screen at any point during game play, simultaneously press and hold the **A**, **B**, **X**, **Y** and Start Buttons.

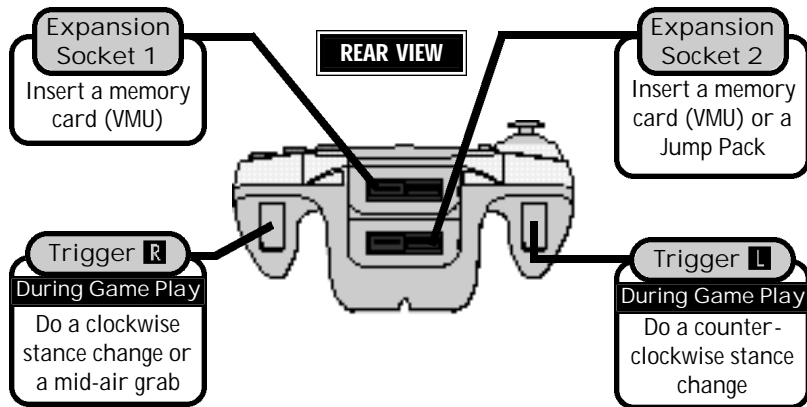

CAUTION

*Never touch the Analog Thumb Pad or Triggers **L/R** while turning the Dreamcast power ON. Doing so may disrupt the controller initialization procedure and result in malfunction.*

BOARD MANUEVERING TIPS



jumping

The height and range of a jump depends on how long the Jump Button (A) is held prior to the jump. During a jump, the speed of the boarder will decrease and the direction cannot be changed. However, if your boarder bails and takes a tumble or when they have slowed down to 0 MPH, by pressing the Jump Button repeatedly it is possible to accelerate a bit.

turning

Maneuver left and right with the Analog Thumb Pad or D-Pad while pressing the Edging Button (X) to execute edging turns. To rail a curve, cut an edge while turning the board to decelerate while making a sharp turn.



grabbing

Press the Grab Button (B or R) in mid-jump to perform tricks while catching air. Also, use the Grab Button while surfing the slopes to perform ground tricks. For details, see p. 9.



guarding

Press the Guard Button (V) to soften the impact of objects the boarder may slam into or to demolish obstacles blocking the boarder's path.



centering and speed

Press the Analog Thumb Pad or D-Pad (up) to have the boarder crouch forward to center their balance and prevent spills while shredding over bumpy or rough terrain. Press (down) to have the boarder squat back to streamline and gain a bit of speed on a straightaway.



**Select "KEY ASSIGN" from the options menu to modify the button assignments for the controls.*

BASIC TRICKS

Perform basic snowboarding tricks by rotating or grabbing parts of the board in mid-air. Busting tricks off checkpoints or cliffs will earn trick points corresponding to the difficulty level of the tricks performed. So let's start off by practicing some basic moves!

grab tricks

Press a Grab Button (B or R) when the board is in mid-air to perform a grab trick. Bust multiple grab moves in succession or hold one grab for an extended length of time to earn higher trick points. Through different button/trigger and (up) (down)

Indy	(B)
Mute	(up) + (B)
Tailgrab	(down) + (B)
Method	(R)
Tweak	(up) + (R)
Melancholy	(down) + (R)

combinations, up to six types of grab tricks are possible. Keep in mind that whether the trick is complete or not, if your boarder attempts to land while still grabbing the board, they're gonna pack painfully. And as you'll soon realize, taking a tumble means no trick points.



rotation tricks

To perform a rotation trick while riding, press and hold the Jump Button while pressing the D-Pad or Analog Thumb Pad in the direction you wish the boarder to rotate. Once you release the Jump Button the boarder will rotate in mid-air in the direction the D-Pad or Analog Thumb Pad was pressed. For example, pressing (left) or (right) will result in a horizontal spin, the easiest rotation trick. The rotation speed of the spin is determined by how long (left) or (right) was pressed. It is possible to perform flips (vertical), spins (horizontal) and misty flips (diagonal) while catching air. Be sure to take care when landing because if the direction the board is facing differs considerably from the direction of the course, or if the inclination of the board is too steep, the boarder will crater hard.

ground tricks

You can also use the Grab Button (B) to perform manual tricks while riding along a course to earn extra time. Unlike grab or rotation tricks, you do not receive trick points as they are made, however, their value is reflected in the TOTAL score tally as a bonus for earned extra time. While performing these manual moves you are unable to turn or jump however, you will maintain the same speed as normal stance boarding. To return the boarder to a normal stance, release the Grab button.

Front Manual ↑ + B
Wheele Manual ↓ + B



ADVANCED TRICKS

combo tricks

Certain rotation and grab move combinations (combos) can earn higher trick points. Execute combos by performing combinations of grab/rotation moves in the same "trick" (the time between the jump and landing). For example, jump and do a grab move and then if you can manage to begin a second grab move before the follow-through of the first move is complete, the two moves will be executed consecutively in the same trick. This is a combo trick. But... don't overdo it! If you try to cram too many moves into one trick, your boarder may not make the landing in time and take a tumble.



inverted tricks

The method used to perform this trick is basically the same as when performing a horizontal rotation trick. While pressing and holding the Jump Button (A), press and hold ↑ or ↓ and when the Jump Button is released the boarder will begin to rotate. The rotation speed is proportional to the length of time ↑ or ↓ was pressed. Of course the angle of the board in relation to the ground surface is essential to making a successful landing. Obviously, if you attempt a landing while the boarder is upside down, your boarder will crash-land.

specialty tricks

Each character has two unique specialty tricks, that can be executed via a trick combo that acts as a command. All you have to do is bust the right combo for the right character to make these phat moves happen. By memorizing the commands that execute each character's specialty trick you can expect to earn even higher trick points. (For details on the commands for each character's specialty tricks, see p. 12-13)

EXPERT TRICKS

misty tricks

Again, the method used perform this trick is basically the same as when performing a horizontal or vertical rotation trick, except that you press and hold the D-Pad or Analog Thumb Pad diagonally. While pressing and holding the Jump Button, press and hold ↘, ↙, ↗ or ↖ and when the Jump Button is released the boarder will begin to rotate. The rotation speed is proportional to the length of time ↘, ↙, ↗ or ↖ was pressed. Compared to a vertical or horizontal rotation trick, landing a Misty is relatively more difficult, so the trick points awarded are higher.



earning the highest possible trick points

It's possible to earn an even higher overall trick point total by combining combo and specialty moves in the same trick. The more combos you manage to execute in one trick, the more trick points you will earn. As explained previously, a specialty trick requires a certain combo command to execute. If you add in another move just prior to making the combo command, the specialty trick will then be preceded by two tricks. Of course, the specialty trick earns the highest points, but the bonus earned by the preceding moves added to the high score specialty trick yields an even higher total point score for the whole trick. If you can master this technique and perform it at will, you'll be earning some mega-high scores.

CHARACTER INTRODUCTIONS &



Jimmy A sports-loving college student, Jimmy's main interests include rock climbing, mountain biking and video games. He was introduced to the world of snowboarding by his girlfriend - who just happens to work for Salomon. Although a relative newcomer, his athletic nature and ability to "borrow" the best Salomon boards and Bonfire gear have given him a more than decent head start. While his technique needs work, his speed and power are quite promising. **music genre: trance**

sp trick 1 Nosegrab melancholy ➔ indy

sp trick 2 Rewind method ➔ mute

A model and choreographer, this taciturn foxy lady is well known on the slopes as the queen of high speed and jump style. **music genre: house**

Monica



sp trick 1 Puff she Puff method ➔ mute

sp trick 2 Born to be Free tailgrab ➔ melancholy ➔ method

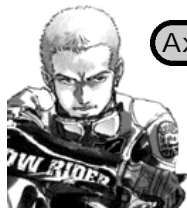

Axel This rocking biker guy is a hot-blooded board freak with a fairly balanced range of skills. **music genre: rock**

sp trick 1 Judo indy ➔ tweak

sp trick 2 Karate melancholy ➔ method

SPECIALTY TRICKS (SP TRICKS)



Ronnie A strong, silent, stern-faced solidier, Ronnie is a serious boarder who can bust some uncharacteristically flamboyant tricks. **music genre: D & B**

sp trick 1 Method Vertical tweak ➔ method

sp trick 2 Junk Split tailgrab ➔ indy ➔ melancholy

A foul-mouthed, slick-talking, hip-hop DJ with an intriguing mix of quickness and technique. **music genre: hiphop**

DJ Ken



sp trick 1 Missile jump + ⬆ + grab + guard

sp trick 2 Rocket Dive jump + ⬇ + grab + guard



Tia This cute, young, high school girl loves to club to techno but on the slopes she is one fine trickstress with an uncanny sense of balance. **music genre: techno**

sp trick 1 Stale Fish tailgrab ➔ indy

sp trick 2 Aquarius mute ➔ method

This carefree Rasta-man, who is never without a smile, will blow you away with his high-flying jumps and super-stoked technique. **music genre: reggae**

Bob



sp trick 1 King Step tailgrab ➔ melancholy ➔ method

sp trick 2 Carbine mute ➔ method

GAME MODES

free ride

These sloped courses feature a variety of obstacles and numerous checkpoints, where extra time can be earned by performing tricks. Make sure your boarder makes it to the goal within the allotted time, or you're a loser! The five main courses and the requirements that must be met to gain access to them are as follows:



Course 1

Bone up on your skills with this slope-style practice level course. Be sure to mind the sheep!



Course 2

Complete Course 1 to ride this tree covered run. Avoid the gullies and don't hurt the trees!



Course 3

Place in the top 3 for Course 2 to hit the big bad city in a snowstorm. Don't broadside the buildings!



Course 4

Place in the top 3 for Course 3 to go underground on this historical trek. Watch out for them bones!



Course 5

Place in the top 3 for TOTAL in Course 4 to board this radical track with some freaky hairpin turns!

super pipe

Bust multiple tricks and catch tons of air in this gnarly halfpipe mode. Make sure your boarder makes it to the finish line at the end of the course within the allotted time and then watch as the total performance results are displayed. In addition to the points acquired along the way, the overall evaluation also includes the content and form of the tricks performed. Also, the background music will change according to the types of tricks made.

"Super Pipe" Compared with our previous halfpipes, this baby features a section with an oversized lip that'll guarantee you'll catch some major air.



"Extra Super Pipe" The design for this truly intense course was based on an amusement park. Conquer this bad boy and you'll be ready for just about anything! However, to earn the right to ride on this course you'll have to place in the top three rankings for the Super Pipe. Good Luck!

GAME MODES

match race - BATTLE

Compete against your favorite rival using this novel racing mode where trick expertise is key. By busting tricks you can earn attacking power or extra thrust, both of which can have more effect on the race outcome than mere speed. Select from two types of challenges, a split-screen position battle called "Line Versus" or a rocket-booster race called "Trick Boost".

"line versus"

A completely new and unique aspect to this mode is the ability to win a match race by using the split-screen to your advantage. Execute tricks to effect a "line attack" which will move the dividing line of the split screen, shrinking your opponent's screen and making their race much harder. If done enough times you can even shut them completely out and win. Of course, you can still win the old-fashioned way of reaching the goal first but by using the following techniques, you'll be able to easily defeat more speedy opponents and improve your chances of victory.

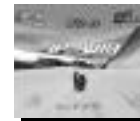

Executing a Line Attack To earn one line attack mark (or one line attack) perform a trick (jump to landing) that earns a minimum of 300 points. For example, if you do a combo that earns a total of 689 trick points, you'll receive two line attack marks. But, if you perform two separate tricks that earn 270 and 210 respectively, you won't earn any line attack marks. You must earn more than 300 trick points for each trick performed to earn one line attack mark. Technically, it only takes seven line attacks to obliterate your opponent but, since your opponent can recover by line attacking you, the dividing line can get pushed back towards your side. Also, remember that just any trick won't automatically earn enough total points for a line attack. With the exception of some grab moves made in trick areas, a combo of two or more moves is the minimum requirement to earn a line attack mark. Don't forget that in addition to the grab, rotation and specialty trick points, you also earn finish points for landing correctly at trick areas.

GAME MODES

Increasing the Score Value Ratio Another important factor of the line versus match race is the score value ratio displayed at the top of the screen. The score value awarded for tricks is revised according to this number. The higher this number is, the more points awarded per trick. This means that a player with the higher ratio can execute line attacks easier because the value of their trick points will be higher. The ratio fluctuates according to the following conditions:

- A) Whenever you receive a line attack (the screen shrinks) this ratio will increase a fixed amount. Likewise, whenever you succeed in executing a line attack your ratio will decrease.
- B) The ratio will automatically increase whenever a checkpoint is passed.
- C) For the leading boarder, the increase is 0.3 and for the lagging boarder the increase is 0.7.
- C) The ratio will increase 0.1 for every obstacle destroyed.

Remember to consider factors such as your character and board when planning your strategy. Particularly with B), where the amount of ratio increase fluctuates according to the position of the boarder, a ratio change will occur in every 3 course sections. In the opening section the ratio is low but it increases bit by bit over the course of the race. By the final section, this ratio can effect a huge attack. Although it is easy to earn line attack marks at the trick areas, marks can be earned anywhere on the course. Therefore it is better to hone your boarding technique to the point where you can bust high scoring tricks anywhere and everywhere.



"trick boost"

In this battle mode, use the Guard Button to give your boarder a jet-boost that will propel them at super high velocity. However, activating the speed boost requires "boost power points" which can only be received by earning trick points at the trick areas. There is no minimum or maximum limit to the trick points that can be earned and all the boost power points are cumulative and can be used at any time. The more trick points earned, the more boost power points your boarder will receive so bust some bodacious tricks and blow your opponent away!

GAME MODES

match race - FREE RACE

This mode is for those who prefer a pure and unadulterated race. Select whether to compete in time, trick or total, preset the size of the split-screen or even establish a handicap. Setting the handicap on will give the lagging boarder a bit of extra speed.

the hidden elements

Meeting certain requirements or placing in the top rankings throughout the course of this game will earn you secret goodies such as hidden courses, characters, boards and other interesting items. So challenge your limits and see what you can uncover!

Hint One Use Axel and aim for the "time" ranking!

Hint Two Using the same type of board, destroy as many course obstacles as possible.

THE RESULTS DISPLAY

Once you complete a course, the current rankings and overall results are displayed alongside the following menu. The results display varies for each game mode. Refer to p. 18 for details. Whenever you place in the top three best rankings, the name entry screen will also appear.

Next Course	Once the necessary requirements are met, select to advance to the next course.
Retry	Try the same course again.
Change	Change characters, board or course and re-start.
Ranking	Display the rankings for this course.
Replay	View a replay of the last completed course or previously saved data.
Save	Save either game or replay data.
Exit	Select to return to the title screen.

THE RESULTS DISPLAY

free ride

Each of the top three rankings for TIME, TRICK and TOTAL are displayed.

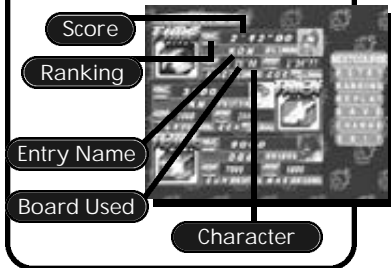

name entry

Every time you place within the top three rankings, you can enter your initials.



super pipe

A maximum of 10 points can be earned in each evaluation category.

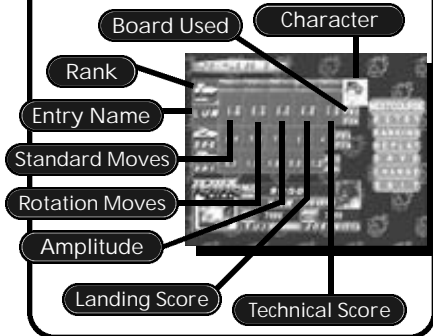

match race

Regardless of the mode, this screen appears at the end of the race to display the detailed results of the match race.



OPTIONS

options menu

Using the Options menu you can modify various game settings, save data, view saved replay data or listen to the background music that is used during the game. Select a menu item using the Analog Thumb Pad or D-Pad and press the **A** Button to enter your selection.



Configuration	Modify various game settings such as sound, Jump Pack settings, etc.
Key Assign	Modify the button assignments of the controller.
Ranking	Display the rankings for each course.
Save & Load	Save game files to or load data from a memory card (VMU).
Replay to Play	View replay data saved to a memory card (VMU).
Juke Box	Adjust the sound volume or listen to background music tracks.

CAUTION

A memory card (VMU) is required to save game files.

Never turn OFF the Dreamcast power, remove the memory card (VMU) or disconnect the controller while game data is being saved.

credits

The following credits list the staff responsible for the localization, marketing and manual production for the U.S. version of Rippin' Riders. Credits for the original development staff are listed in the game itself.

SEGA of America Product Development

Localization Producer

Osamu Shibamiya

Lead Tester

Paulita Escalona

Assistant Lead

Gabrielle Brown

Benjie Galvez

Marketing

Associate Product Manager

Stacey Kerr

Director of Product Marketing

John Golden

SEGA of Japan Manual Production Staff

Writer/Editor/Translator/DTP

Monika Hudgins

DTP & Design Advisor

Yoshihiro Sakuta

Supervisor

Kaoru Ichigozaki

Special Thanks

Kats Sato

Makoto Sunaga

Mike Calabro

Greg Weber

Hide Nakamatsu