

For  
ATARI • 2600  
Game System

# KUNG FU SUPERKICKS™

Earn your karate belts as  
You face the dangerous  
Warriors who lie in  
ambush on your  
seven screen  
journey  
to the  
monastery!

PURSUIT

OF

KUNG FU

SUPERKICKS™

THE

NINJA

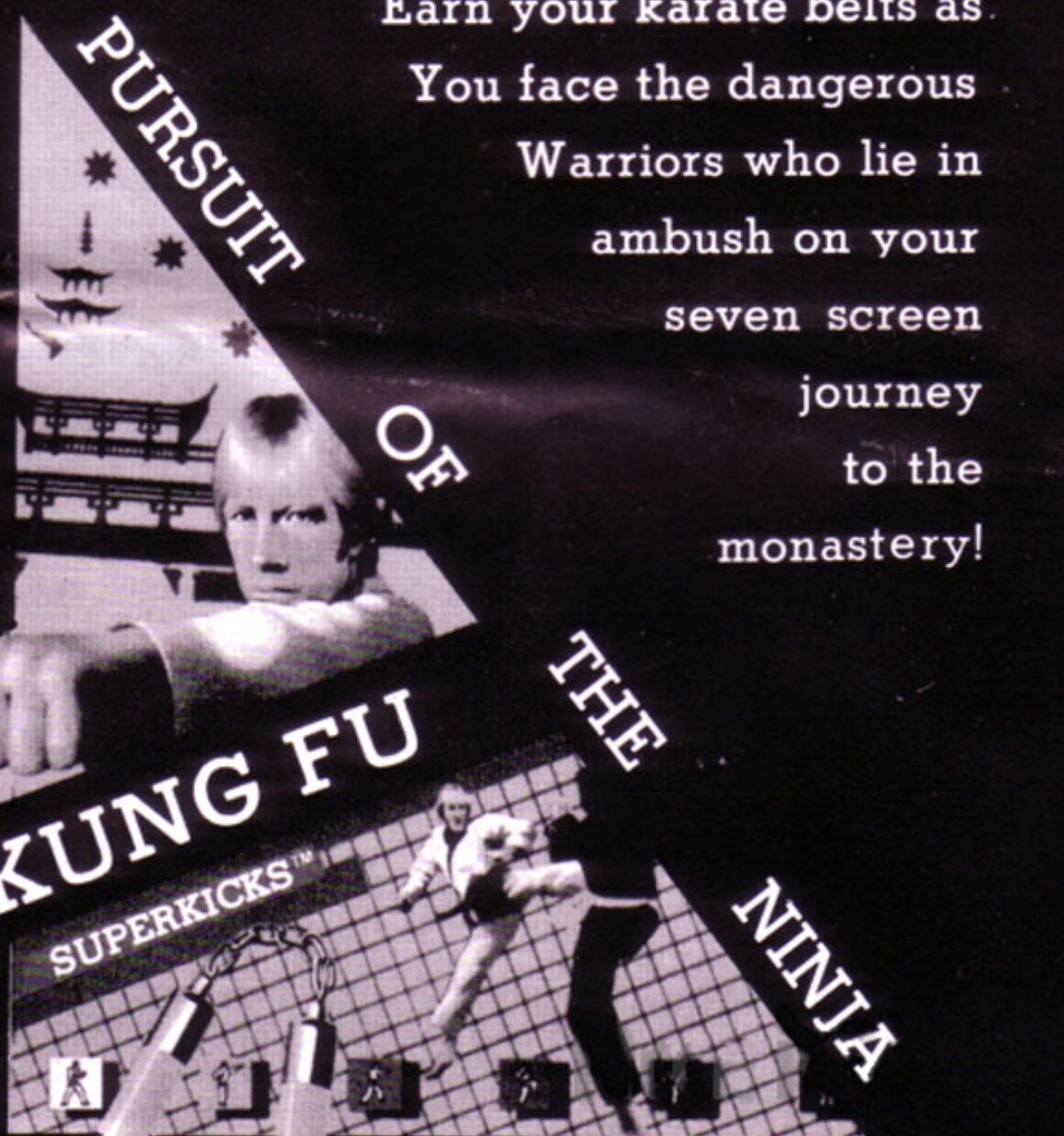



# Get Ready to Play KUNG FU SUPERKICKS™

1. Hook up your video game system. Follow the manufacturer's directions.
2. Always turn the console power switch "OFF" when inserting or removing a TELEGAMES® cartridge. This will protect the electronic components and help prolong the life of your games.
3. Now turn the power on. If no picture appears, check connection of your game console to TV; then repeat steps 1, 2 and 4.
4. For a single player game use left joystick and fire button. For a two player game attach both joysticks, player #1 use the left joystick and fire button and player #2 use the right.
5. Console game select switches allow you to choose one or two players. Game reset restarts the game to #1 player.

**NOTE:** You may need to adjust your Vertical Hold on your T.V.

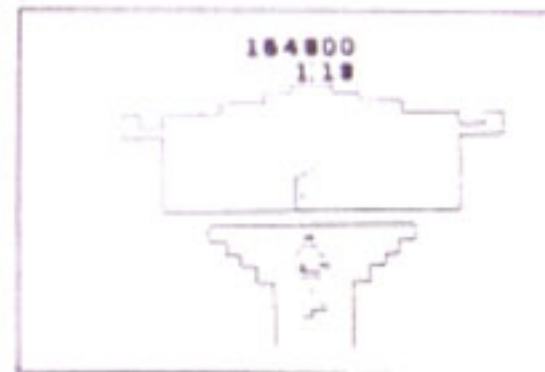

### 3. Screen #7 — THE MONASTERY

When you have sharpened your karate skills by earning your Black Belt, you will move to the entrance of the monastery. BEWARE! The monastery is guarded by a huge force of the dreaded NINJA. Enter the candlelit building and defeat the enemies to score points.

## EARNING YOUR BELTS:

- You begin the journey as a White Belt, or beginner.
- Successfully defeating enemies on every attack screen and choosing the proper path to the next path intersection you will earn the next level belt and gain a minute of playing time.
- The order of belts is as follows:
  - Screen One — White Belt
  - Screen Two — Orange Belt
  - Screen Three — Green Belt
  - Screen Four — Purple Belt
  - Screen Five — Brown Belt
  - Screen Six/Seven — Black Belt

## PLAY ACTION — Screen 1 PATH TO THE MONASTERY

When the game begins, you will be standing at an intersection. You must set the reset switch and the game starts. Your time will show 6:00 in which to complete your journey to the monastery. Choose a path and using your joystick, move up the chosen path. There is only one correct route, so use your sixth sense, intuition, to help as a guide. A fallen tree indicates a blocked path. At the end of the path lies the entrance to the monastery. Walk through the door and face the NINJA. Time is lost by going off the path through the tall grass.

Bonus time, bonus points, and your new belt will be awarded to you after you have successfully walked to where the path is intersected by a choice of paths leading to the monastery.

### Bonus scoring is as follows:

1. Orange Belt — 10,000 points
2. Green Belt — 20,000 points
3. Purple Belt — 30,000 points
4. Brown Belt — 40,000 points
5. Black Belt — 50,000 points

A bonus of one minute's playing time is added when you receive each new belt.



# PLAY ACTION — Screen 2

## ATTACK ON THE ROAD

You will encounter the dangerous YAKUZA warriors. The YAKUZA warriors are known for protecting their upper bodies (shown by their arm movement). Because you know this about the YAKUZA, you can defeat them by using the THRUST KICK which attacks the lower body. You will THRUST KICK by pushing the joystick DOWN and pushing the fire button.

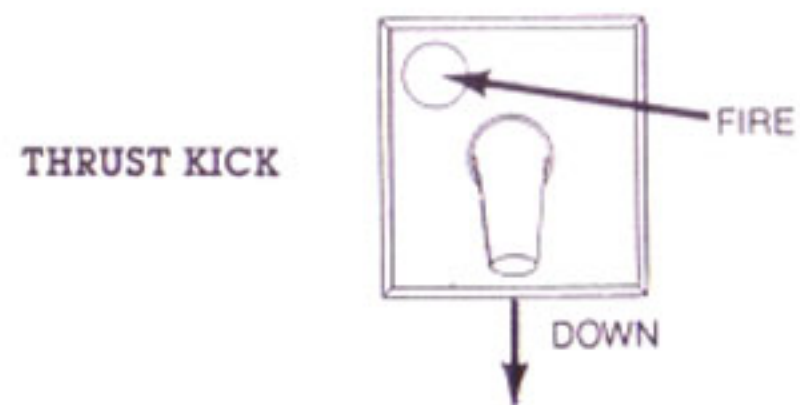

You will kick in the direction you are facing. You must kick the YAKUZA in the body in order to defeat them. Avoid running into the enemy or his punches will knock you down temporarily. When you are knocked down, you are very vulnerable to being hit with a CHINESE STAR or "SHURIKEN". There are two ways to avoid them:

1. Using your joystick, move to dodge all stars thrown.
2. Use the forearm block to deflect the stars by pushing the joystick either right or left and push the fire button.

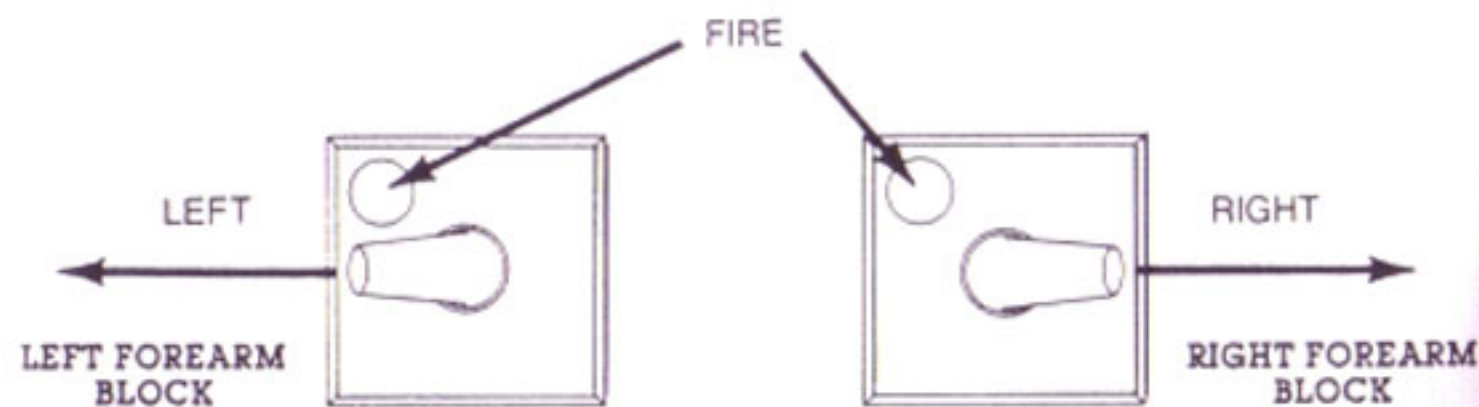

The star must hit your forearm in order to be deflected! So be careful. The YAKUZA warriors are worth 100 points each, and you must defeat three enemies successively in order to continue your journey and receive your Orange Belt.

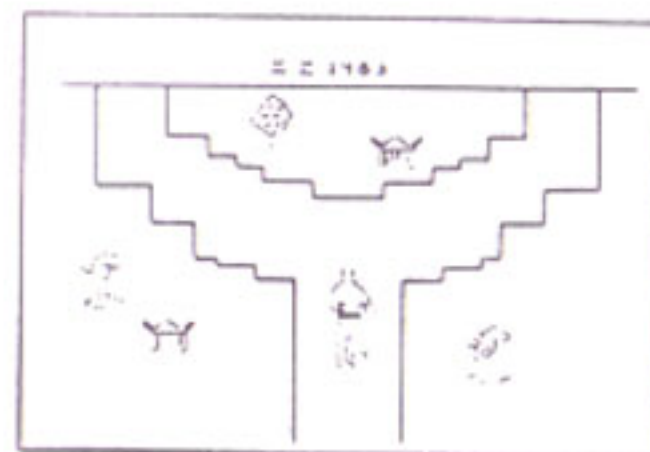

# KUNG FU SUPERKICKS Video Game

You are in an oriental land and you are trying to save a famous leader who is being kept prisoner in an ancient monastery. As you

start out, you have a White Belt and must succeed to master the karate martial arts and achieve a Black Belt in order to enter the monastery which is guarded by the dreaded NINJA.

You must choose a path carefully as the tall grass will slow your progress and attackers will cause you to defend yourself. Some of the paths are blocked by impassable barriers which will make you take an alternate route to your goal.

## 1. OBJECT of the GAME:

Achieve the coveted Black Belt and enter the monastery, while collecting as many points as possible before time runs out. Highest score wins.

## 2. CONTROLS:

a) one player game: Use LEFT JOYSTICK and FIRE BUTTON.

b) Two player game:  
 Player #1: Use LEFT JOYSTICK and FIRE BUTTON.  
 Player #2: Use RIGHT JOYSTICK and FIRE BUTTON.

## 3. SCORE DISPLAY:

a) Top row of digits is your SCORE. The color of the current belt you have earned is shown as your SCORE COLOR.  
 b) Bottom row of digits is your TIME. This is the amount of time you have remaining in the game to complete your goal.

## 4. GAME SWITCHES:

a) Game Select—Choose between one and two players.  
 b) Game Reset—Restarts game to player number one.



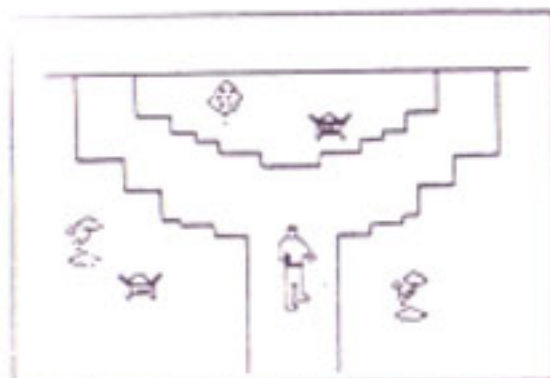

## GAME LAYOUT:

There are SEVEN game screens in the game, a scrolling path to the monastery, and each of the fight screens in close-up perspective.

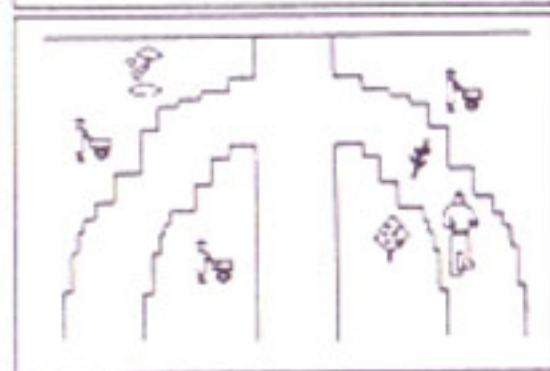

### 1. Screen #1 — PATH TO THE MONASTERY

As you begin your journey to the monastery, you must move up the brown path. Do not wander off the path or the tall grass will slow your progress and you will lose valuable time. Choose the correct route to avoid impassable barriers. Be prepared to defend yourself against attacking enemies. As you proceed through each screen you will learn new martial arts skills and gain a new color belt.

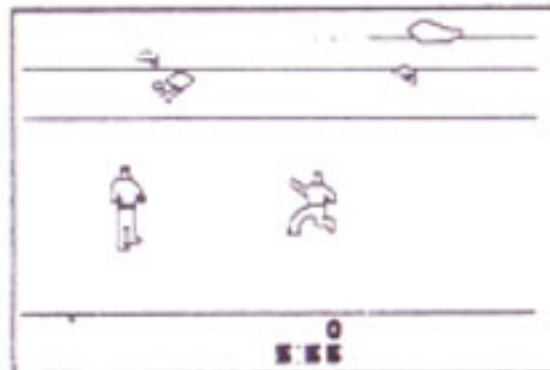

### 2. Screens #2-#6 — JOURNEY OF TRAINING

When you are attacked, you must defend yourself by using your karate skills. Each enemy that you defeat will give you points. Each group of enemies that you defeat in a fight screen will allow you to continue on your journey to the monastery. If you chose the correct path, you will advance to the next belt. During the fight screens the enemies may knock you down, but you can quickly get up and defeat them. Avoid the dangerous CHINESE STARS which the enemies throw. If struck by a Star, you will be injured and find yourself lying on the ground on the path at the beginning of the screen where you were defeated. Get up and try again! Each level of enemies will be more difficult than the last. You must earn your belts!

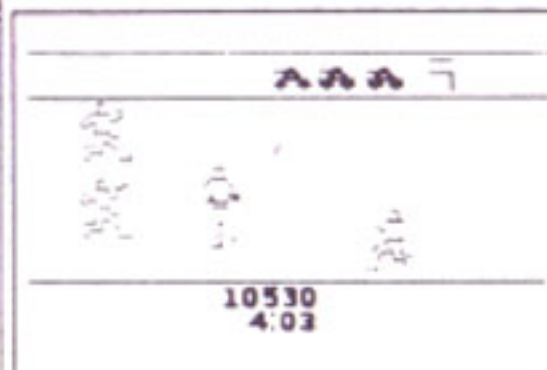
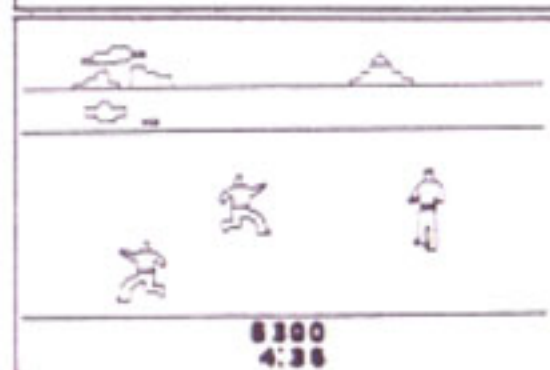
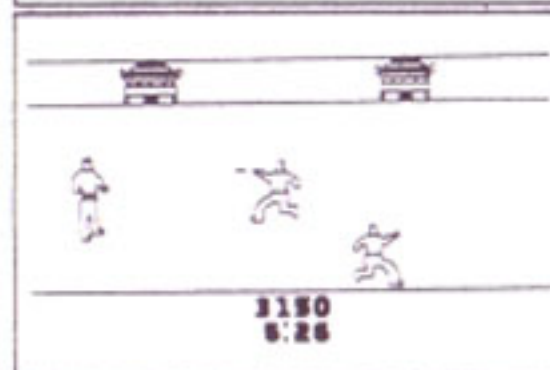
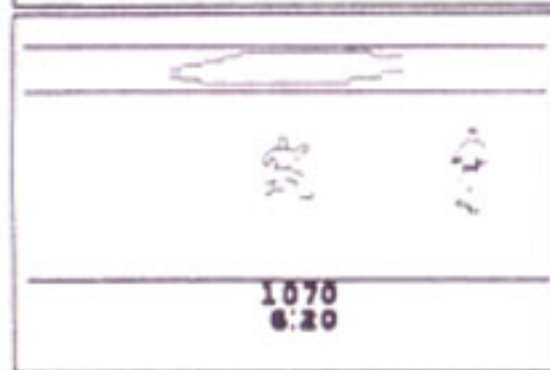

## PLAY ACTION — Screen 6 THE APPROACH TO THE MONASTERY

The last test on your journey as you approach the monastery is getting past the GOEMON guards. These treacherous villains can be defeated by any of the skills which you have learned, but you must carefully observe how they are defending themselves. If they are protecting their lower bodies, use the PUNCH. If they are punching high with their arms, use the THRUST KICK. The SOMERSAULT SUPERKICK may be used at all times. Because the GOEMON are fast and tricky, you may want to try a REVERSE SUPERKICK (start your SUPERKICK in one direction and while you are in the air, move the joystick in the opposite direction). This is a great move for close action fighting.

Again, avoid the punches and kicks of the GOEMON and watch out for the STARS. The GOEMON guards are worth 500 points for each man defeated. You must eliminate seven enemies successively to get back on your path and move up to the gates of the monastery.

Only when you have done all of this will you be awarded the most highly honored karate belt, the Black Belt.

## PLAY ACTION — Screen 7 INSIDE THE MONASTERY

The monastery is guarded by the most feared and deadly assassins of all, the NINJA. Inside the candlelit monastery, the NINJA will try to repel your assault on their stronghold. They are clever, but they can be defeated. The NINJA who are protecting their lower bodies, can be overcome with a PUNCH. Those NINJA who are protecting their upper bodies are vulnerable to a THRUST KICK. The SOMERSAULT SUPERKICK can be used at all times. The NINJA warriors are masters of karate and camouflage. Once you have eliminated three of their men, the NINJA realize you are to be taken seriously and begin to use their camouflage abilities to deceive you. They begin to appear and disappear at different times, trying to avoid your blows. As you defeat the NINJA assassins (in multiples of three), their camouflage abilities increase. Your timing and intuitive senses are most important, for even though NINJA are camouflaged they can still be defeated! Destroy all NINJAS. The NINJA assassins are worth 600 points each



# GAME ENDING

The game ends when time expires. The scores are displayed as follows:

1. One player game - Score is displayed in the color of the highest belt that you received.
2. Two player game - Scores are alternately displayed (Player One - the score is white, Player Two - the score is black).

To play again press GAME RESET on your console.

# GAME SUMMARY:

Move up the path to the monastery as fast as you can, defeating attackers with your karate skills. Earn points by gaining different colored belts and defeating enemies. Gain time by receiving new belts.

# JOYSTICK SUMMARY

Moving into a defense position on the fight screens. Without touching the fire button you may move in any of eight directions.

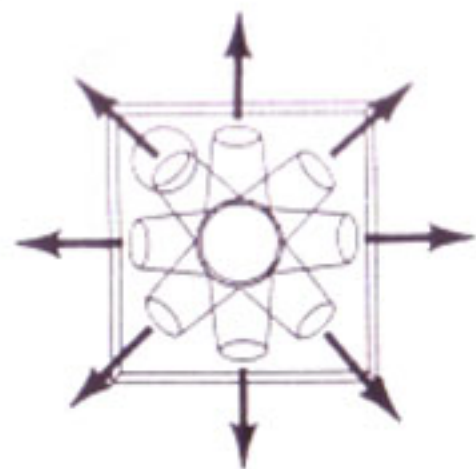

FIGHT SCREEN POSITIONING

While depressing the fire button, you may defeat enemy warriors with the following joystick moves:

**LEFT FOREARM BLOCK:**  
Screens 2 and 3

**LEFT SOMERSAULT  
SUPERKICK:**  
Screens 4 - 7

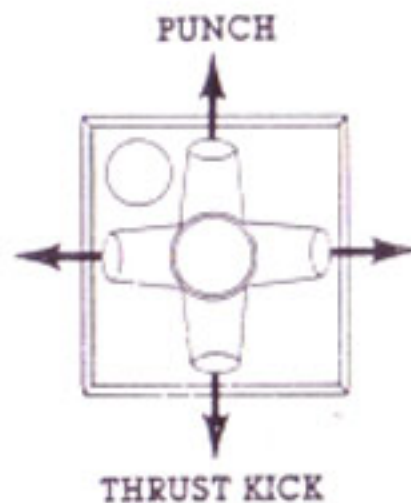

**RIGHT FOREARM BLOCK:**  
Screens 2 and 3

**RIGHT SOMERSAULT  
SUPERKICK:**  
Screens 4 - 7.

THRUST KICK

# PLAY ACTION — Screen 3 AMBUSH ON THE WATERFRONT

As you pass by the lake, the band of thieves known as DOROBO make their attack. The DOROBO warriors protect their lower bodies (shown by arm movement), so you know they are vulnerable to a PUNCH to their head or upper bodies. You will PUNCH by pushing the joystick UP and pushing the fire button.

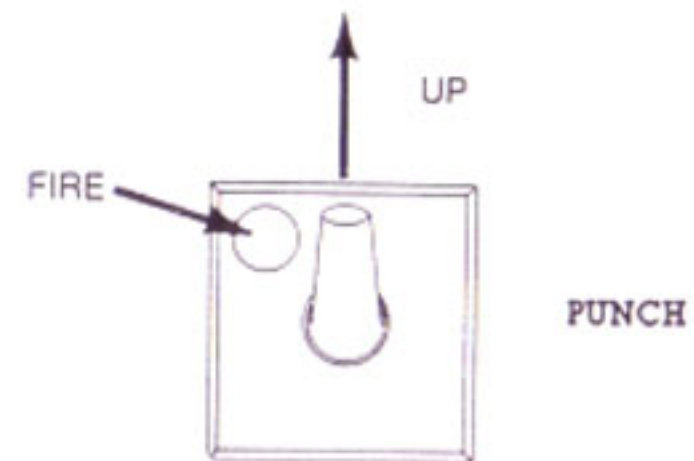

As you practice the new move, remember that you must face the enemy and PUNCH. You must PUNCH the DOROBO in the body to be most effective. Again, running into DOROBO will knock you down. Because of their defenses, your THRUST KICK will not be effective, but you may still use the FOREARM BLOCK to defend against STARS which are thrown at you. The DOROBO warriors which you defeat are worth 200 points each. You must defeat three DOROBO to continue your journey to the monastery and receive your Green Belt.



## PLAY ACTION — Screen 4 THE VILLAGE ATTACK

The leaderless former SAMURAI warriors who have turned mercenary are known as RONIN, and they have taken over the village through which your path runs. The RONIN warriors protect their upper bodies (shown by arm movement), so, like the YAKUZA, they can be defeated by the THRUST KICK. But they are faster and there are more of them. Now you will learn the SOMERSAULT SUPERKICK. To execute the SOMERSAULT SUPERKICK you move the joystick either left or right and push the fire button.

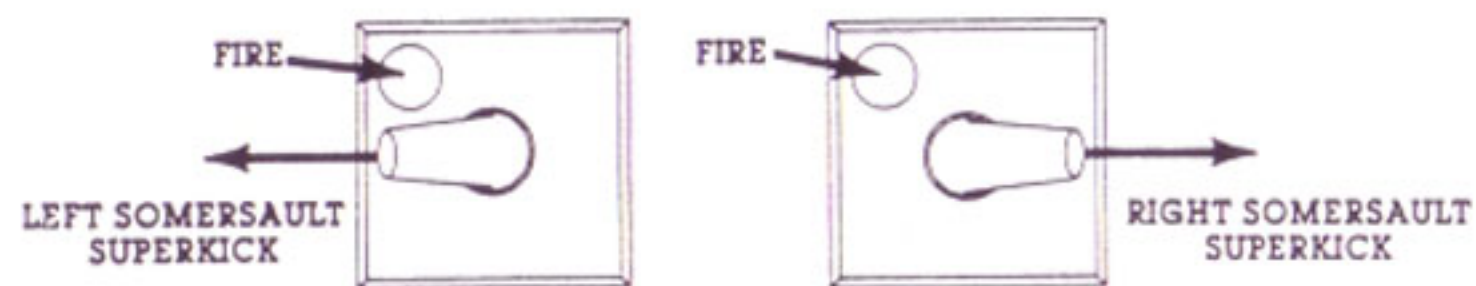

You must THRUST KICK or SUPERKICK the RONIN in the body in order to defeat them. Since you now have this new skill, you will no longer be able to FOREARM BLOCK the STARS which are thrown at you, so dodge all STARS. You can use the SUPERKICK to jump over STARS which are thrown at you, but your timing must be right or you will be defeated.

The RONIN warriors which you defeat are worth 300 points each, and you must knock out five of them successively in order to continue your journey and receive your Purple Belt.

## PLAY ACTION — Screen 5 ATTACK IN THE FOOTHILLS

The path you are on moves into the foothills where the masked bandits, TENGU, make their attack. The TENGU are known to pounce on the unsuspecting traveler, but you quickly observe they are defending their lower bodies (shown by arm movement) and so, a PUNCH or SUPERKICK, if timed right, can be their undoing.

Because they are masked, it is hard to read their intentions, so you must be quick. Avoid running into their PUNCHES and their quickly thrown STARS. You must get through the foothills as fast as you can for time is running out!

The TENGU warriors are each worth 400 points, but you must defeat six of them in order to continue your way on the path to the monastery and receive your Brown Belt.

The warriors which you will encounter have the following characteristics:

SCREEN	ENEMY	NO. TO DEFEAT	HOW TO DEFEAT
2	YAKUZA	3	THRUST KICK
3	DOROBO	3	PUNCH
4	RONIN	5	THRUST KICK, SUPERKICK
5	TENGU	6	PUNCH, SUPERKICK
6	GOEMON	7	THRUST KICK, PUNCH, SUPERKICK
7	NINJA	?	THRUST KICK, PUNCH, SUPERKICK

### HELPFUL HINTS:

- You must practice in order to learn the timing of karate.
- When using the THRUST KICK, stand with your head slightly higher than the enemy, then pull down on the joystick and press the fire button.
- When using the PUNCH, stand with your head slightly lower than the enemy's shoulders, then push up on the joystick and press the fire button. It is easier to punch the enemies in the midsection than in the head.
- When using the SOMERSAULT SUPERKICK, be sure to time your jump. You cannot defeat an enemy while in the middle of your SUPERKICK. You must complete the SUPERKICK, then kick the warrior.
- Use the SUPERKICK to jump over STARS which are thrown at you in the harder fight screens.
- Good luck on your journey, and PRACTICE!



# 90 Day Limited Warranty

TELEGAMES warrants to the original consumer purchaser of any cartridge or cassette it manufactures that the product will be free of defects in material or workmanship for 90 days from the date of purchase. If defective, return the product along with proof of the date-of-purchase to either your local dealer or, postage prepaid, to:

TELEGAMES USA	TELEGAMES UK
BOX 901	KILBY BRIDGE, WIGSTON
LANCASTER, TX75146	LEICESTER LE81TE

for repair or replacement. This warranty gives you specific legal rights, and you may also have other rights which vary from state to state. This warranty does not cover damage resulting from accident, misuse or abuse.

THIS PRODUCT IS MANUFACTURED UNDER  
WORLDWIDE LICENSE BY

**TELEGAMES**

\*ATARI is a trademark of ATARI, INC.